

www.broderiabucuresti.ro
www.coolibri.ro



**BRODERIA
BUCUREȘTI**



COOLIBRI
UNIFORME PROFESIONALE

Tricouri





Tricouri Personalizate 100% BUMBAC

1. Tricou de bărbat sau de damă?

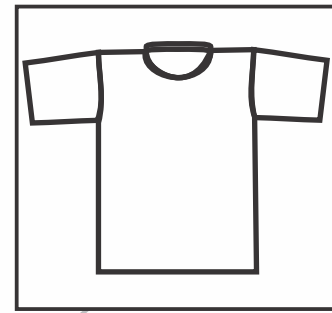

Bărbat

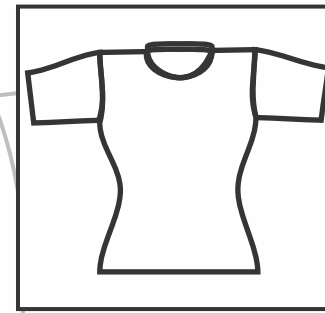

Damă

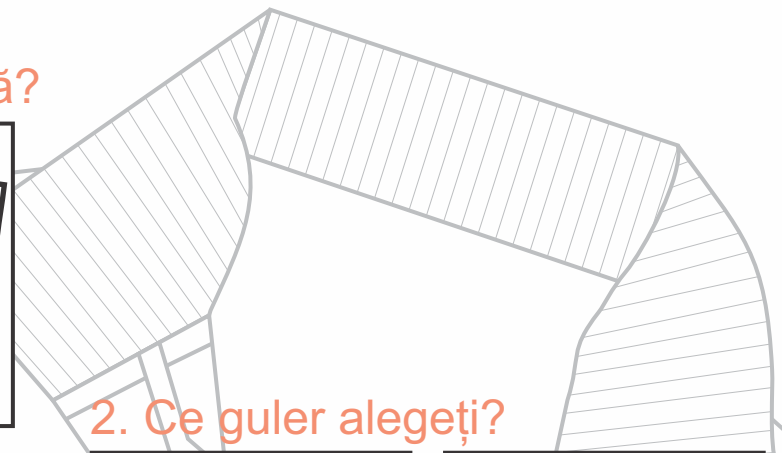

2. Ce guler alegeți?

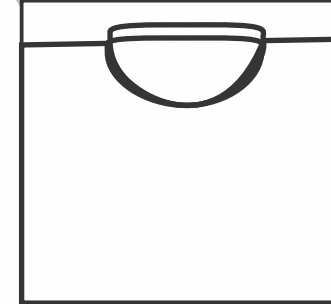

Guler rotund

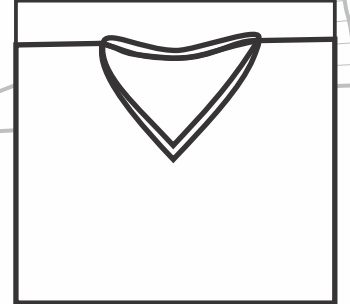

Guler in V

3. Ce model alegeți?

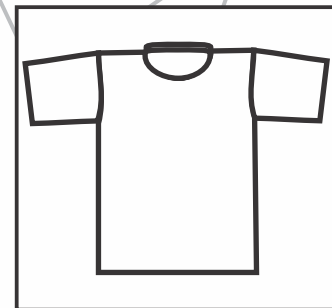

Clasic Fit

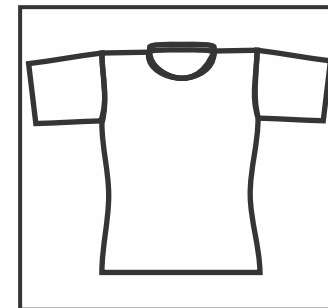

Slim Fit

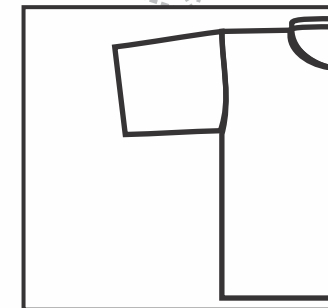

Mâncă scurtă

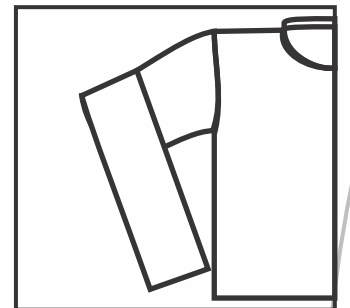

Mâncă lungă

4. Ce tricou clasic sau polo?

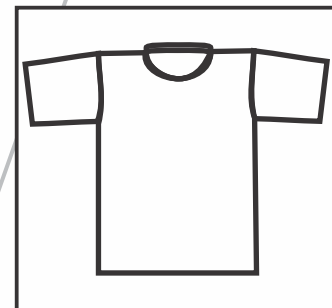

Tricou Clasic

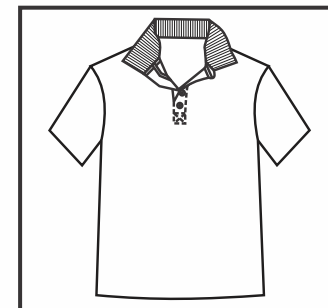

Tricou Polo

5. Ce nasturi polo alegeți?

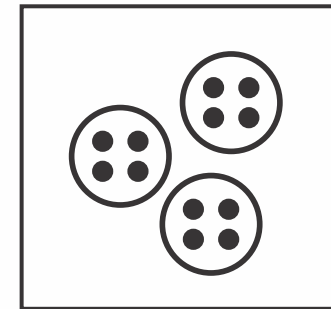

Nasturi Transparenti

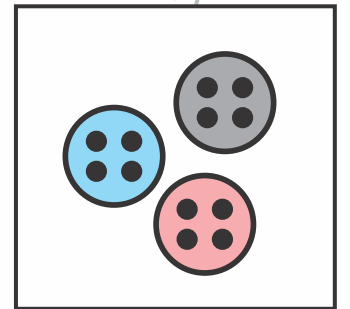

Nasturi Colorați



6: Ce detalii alegeți?

Contrast Mâncă Contrast corp Guler Contrast Contrast mânecă

Contrast spate Contrast piept Contrast mâneci Contrast ață

7. Ce culoare alegeți?

00	51	03	12	28	69	29	67
02	93	05	60	14	15	44	19
08	09	16	92	39	62	04	96
38	23	13	07	49	43	30	64
94	01	11	A1	95	06	27	40

Poți adăuga.....

Tricou Polo Dama
CLASIC FIT

MARIME	BUST	TALIE	LUNGIME SPATE	LUNGIME MANECA
XS	86	78	62	59
S	90	82	64	60
M	94	86	66	61
L	98	90	68	62
XL	102	94	70	63
2XL	110	102	74	65
3XL	118	110	78	67



... o broderie cu
logo-ul tau



Tricou Polo Dama
SLIM FIT

MARIME	BUST	TALIE	LUNGIME SPATE	LUNGIME MANECA
XS	74 - 78	66 - 70	62	59
S	79 - 82	71 - 74	64	60
M	83 - 88	75 - 80	66	61
L	89 - 94	81 - 85	68	62
XL	90 - 95	86 - 90	70	63
2XL	100 - 105	92 - 97	74	65
3XL	108 - 113	100 - 105	78	67



...sau o personalizare
prin transfer termic
sau serigrafie



Poți adăuga.....

Tricou Dama
CLASIC FIT

MARIME	BUST	TALIE	LUNGIME SPATE	LUNGIME MANECA
XS	86	78	62	59
S	90	82	64	60
M	94	86	66	61
L	98	90	68	62
XL	102	94	70	63
2XL	110	102	74	65
3XL	118	110	78	67

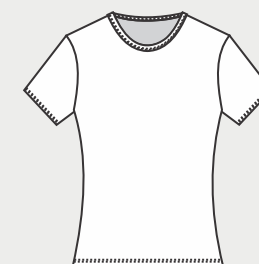

... o broderie cu
logo-ul tau



Tricou Dama
SLIM FIT

MARIME	BUST	TALIE	LUNGIME SPATE	LUNGIME MANECA
XS	74 - 78	66 - 70	62	59
S	79 - 82	71 - 74	64	60
M	83 - 88	75 - 80	66	61
L	89 - 94	81 - 85	68	62
XL	90 - 95	86 - 90	70	63
2XL	100 - 105	92 - 97	74	65
3XL	108 - 113	100 - 105	78	67



...sau o personalizare
prin trasfer termic
sau serigrafie



Tricou Polo Barbati
CLASIC FIT

MARIME	BUST	TALIE	LUNGIME SPATE	LUNGIME MANECA
XS	100	100	65	64
S	104	104	67	65
M	108	108	69	65
L	112	112	71	65
XL	116	116	73	66
2XL	120	120	75	66
3XL	124	124	77	66

Tricou Polo Barbati
SLIM FIT

MARIME	BUST	TALIE	LUNGIME SPATE	LUNGIME MANECA
XS	90 - 93	90 - 93	65	64
S	94 - 97	94 - 97	67	65
M	98 - 101	98 - 101	69	65
L	102 - 105	102 - 105	71	65
XL	106 - 109	106 - 109	73	66
2XL	110 - 113	110 - 113	75	66
3XL	114 - 117	114 - 117	77	66

Poți adăuga.....



... o broderie cu
logo-ul tau



...sau o personalizare
prin transfer termic
sau serigrafie



Tricou Barbati
CLASIC FIT

MARIME	BUST	TALIE	LUNGIME SPATE	LUNGIME MANECA
XS	100	100	65	64
S	104	104	67	65
M	108	108	69	65
L	112	112	71	65
XL	116	116	73	66
2XL	120	120	75	66
3XL	124	124	77	66

Tricou Barbati
SLIM FIT

MARIME	BUST	TALIE	LUNGIME SPATE	LUNGIME MANECA
XS	90 - 93	90 - 93	65	64
S	94 - 97	94 - 97	67	65
M	98 - 101	98 - 101	69	65
L	102 - 105	102 - 105	71	65
XL	106 - 109	106 - 109	73	66
2XL	110 - 113	110 - 113	75	66
3XL	114 - 117	114 - 117	77	66

Poți adăuga.....

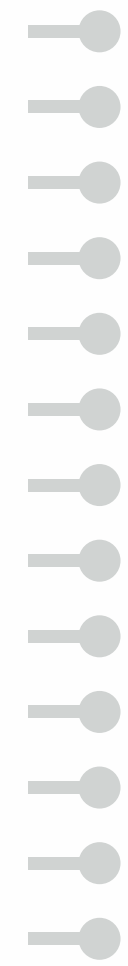
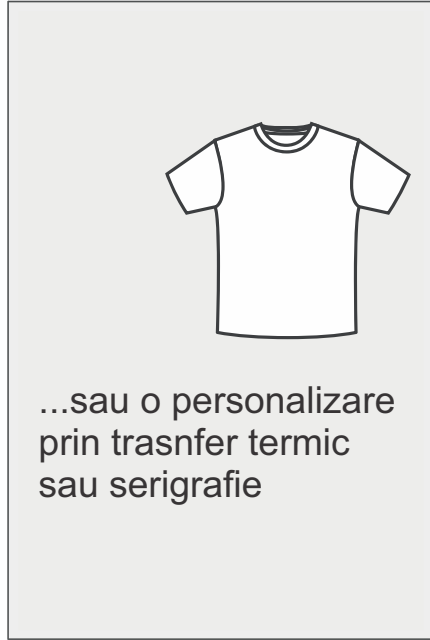

Cămăși

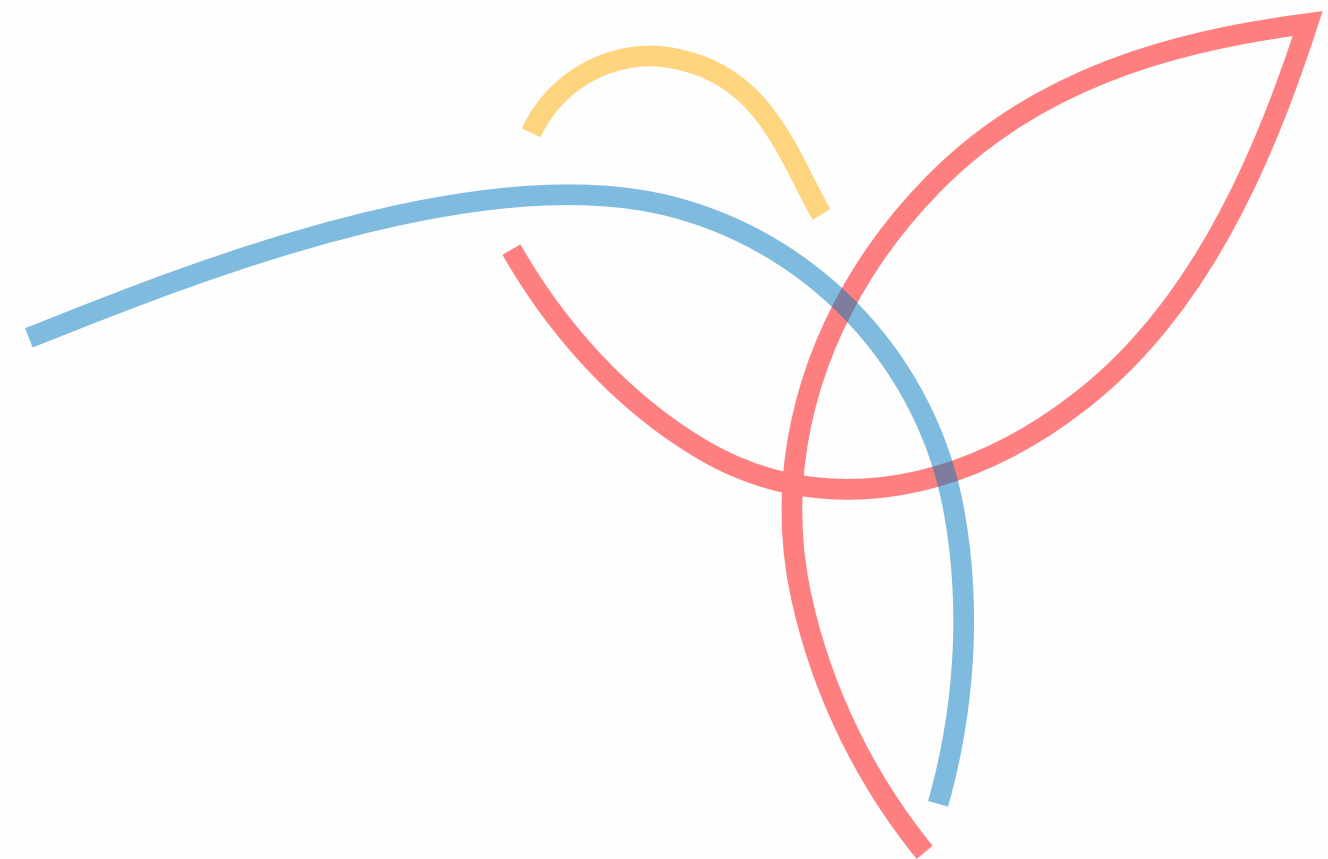



Cămași Personalizate

1. Cămașă de bărbat sau de damă?

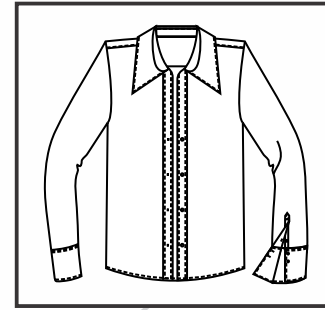

Bărbat

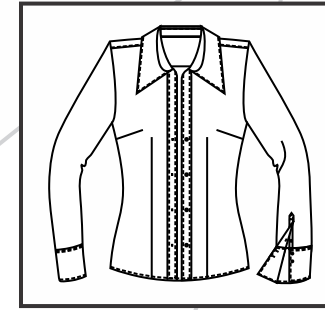

Damă

2. Ce guler alegeți?

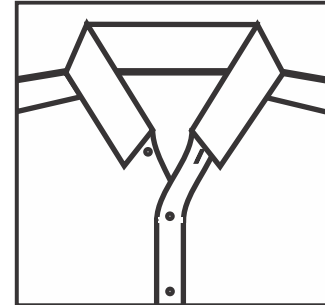

Clasic

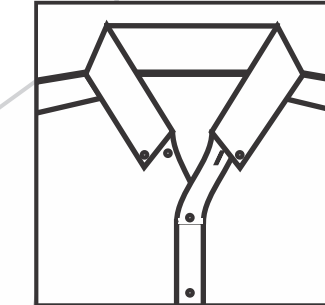

Button Down

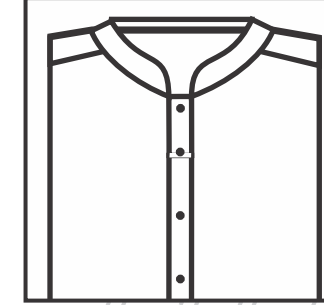

Mandarin

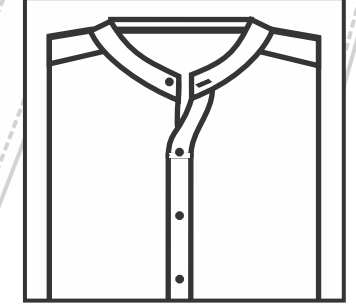

Grandad

3. Ce model alegeți?

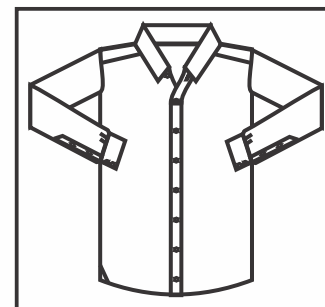

Clasic Fit

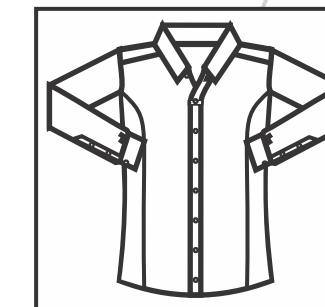

Slim Fit

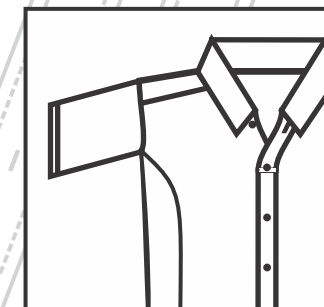

Mâncă scurtă

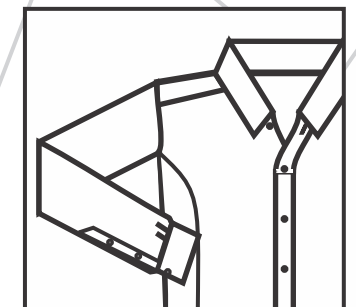

Mâncă lungă

4. Ce fel de detalii?

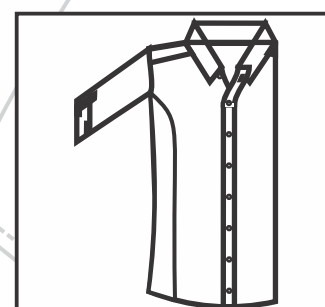

Mâncă rulată

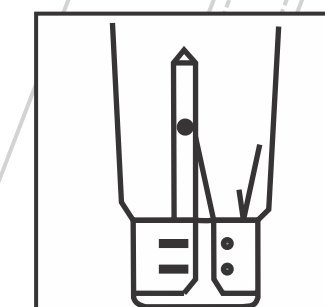

Manșetă cu 2 nasturi

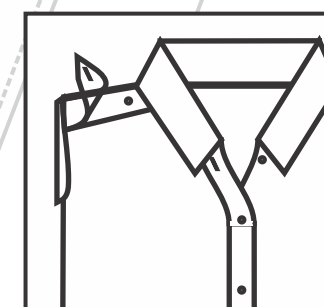

Epoleți



5. Buzunare?

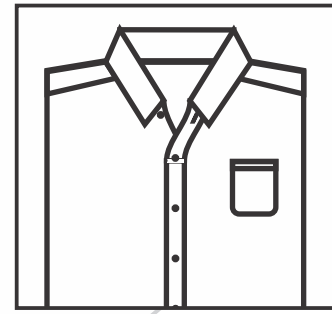

1 buzunar

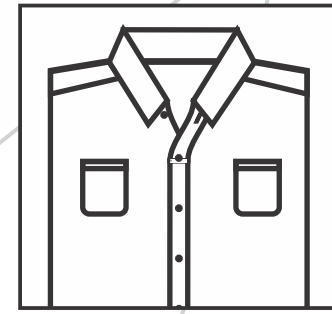

2 buzunare

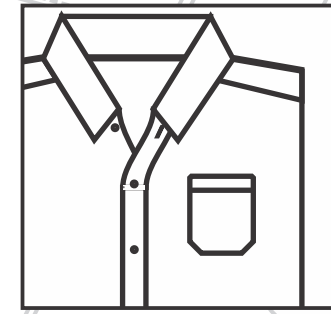

Buzunar colțuri rotunjite

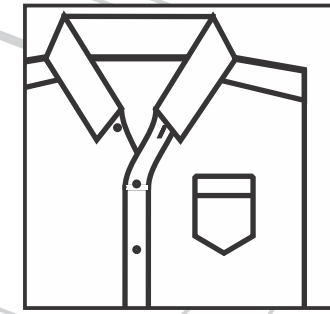

Buzunar cu colț

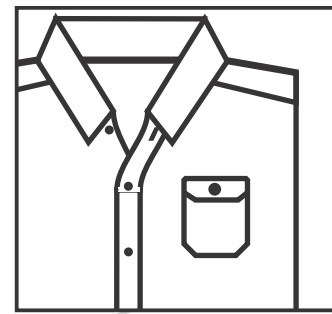

Buzunar cu clapă

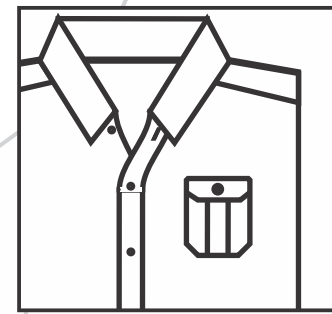

Buzunar cu clapă și fald

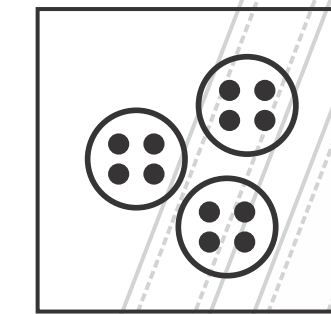

Nasturi Transparenti

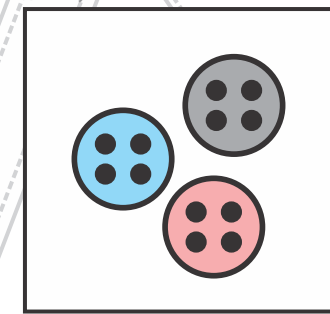

Nasturi Colorați

6. Ce nasturi alegeți?

7. Ce culoare alegeți?

00	51	03	12	28	69	29	67
02	93	05	60	14	15	44	19
08	09	16	92	39	62	04	96
38	23	13	07	49	43	30	64
94	01	11	A1	95	06	27	40

Poți adăuga.....

Cămașă Damă

MARIME	TALIE	BUST	SOLD	LUNGIME SPATE	LUNGIME MANECA
36	78	94	90	59	58
38	82	98	94	60	59
40	86	102	98	61	60
42	90	106	102	62	61
44	94	110	106	63	62
46	98	114	110	64	63
48	102	118	114	65	63
50	106	122	118	66	63
52	110	126	122	67	64
54	114	130	126	68	64
56	118	134	130	69	64
58	122	138	134	70	65
60	126	142	138	71	65
62	130	146	142	72	65



... o broderie cu logo-ul tau

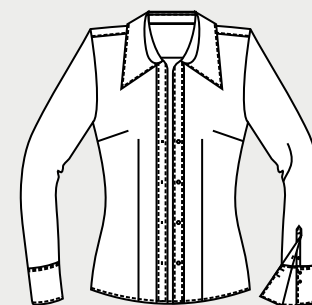

...sau o personalizare prin trasfer termic sau serigrafie



Poți adăuga.....

Cămașă Bărbat

MARIME	BUST	LUNGIME SPATE	LUNGIME MANECA
38	100	76	62
40	104	76	62
42	108	76	63
44	112	77	63
46	116	77	64
48	120	77	64
50	124	77	65
52	128	78	65
54	132	78	65
56	136	78	65
58	140	78	65
60	144	79	65
62	148	79	65



... o broderie cu logo-ul tau



...sau o personalizare prin trasnfer termic sau serigrafie



Tunici



Tunici Personalizate

1. Ce model alegeți?

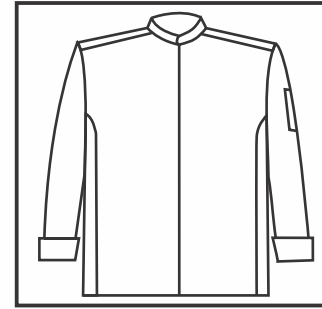

Tunică cu închidere centru

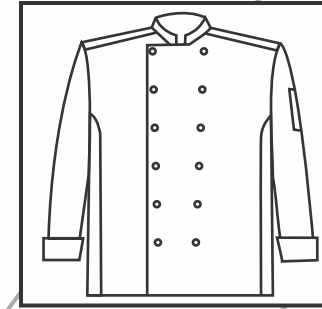

Tunică cu închidere dublă nasturi

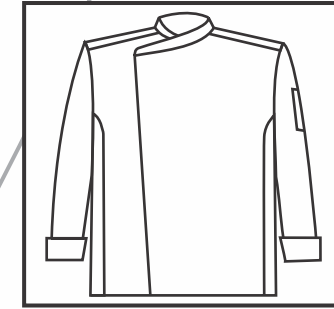

Tunică cu închidere laterală

3. Ce fel de mânecă alegeți?

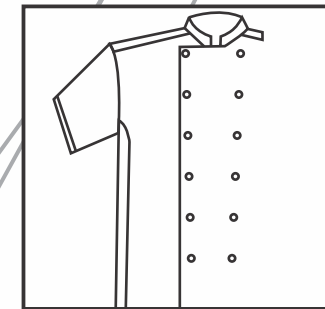

Mâncă scurtă

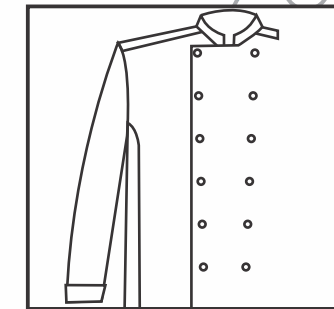

Mâncă lungă

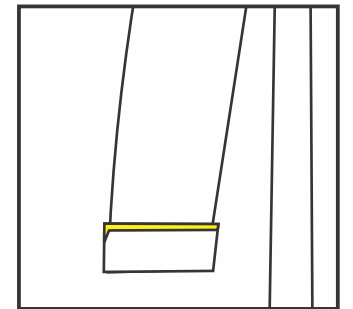

Mâncă cu vipușcă

4. Ce detalii alegeți?

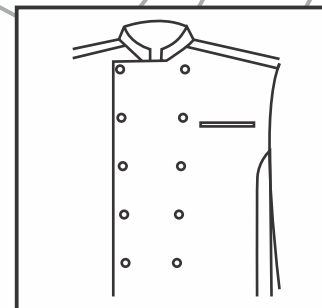

Buzunar refilet

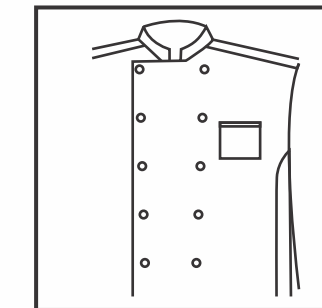

Buzunar pătrat

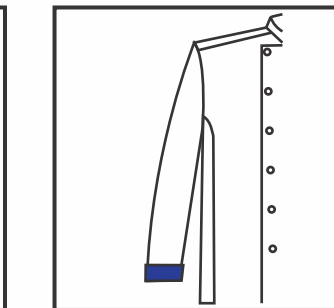

Contrast mânecă

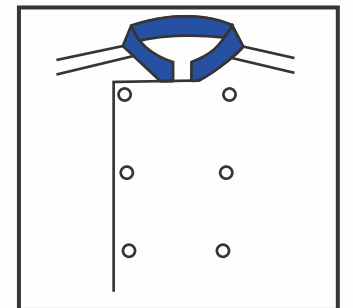

Contrast guler

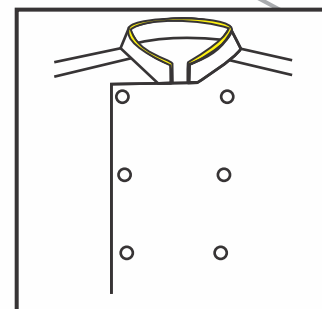

Guler cu vipușcă

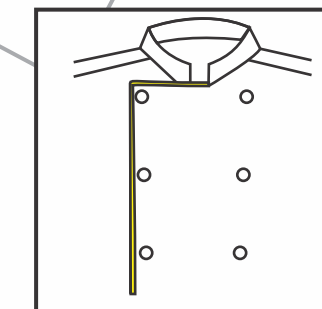

Piept cu vipușcă

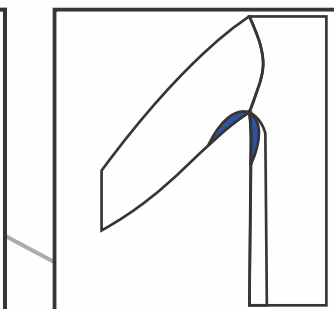

Contrast amănșură

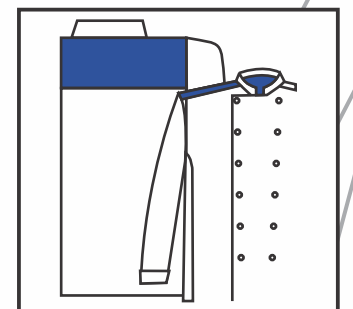

Contrast spate



Tunica Unisex

MARIME	BUST	SOLD	LUNGIME SPATE	LUNGIME MANECA
XS	94	94	61	61
S	102	102	64	62
M	110	110	67	63
L	118	118	70	64
XL	126	126	73	65
2XL	134	134	76	66
3XL	142	142	79	67
4XL	148	148	82	68

Poți adăuga.....



... o broderie cu logo-ul tau



...sau o personalizare prin transfer termic sau serigrafie

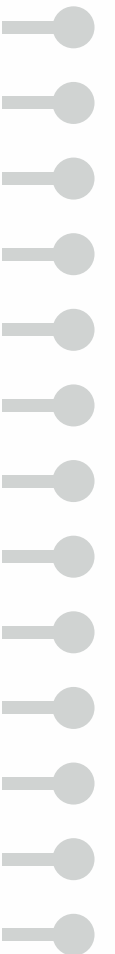



Şorturi





Șorturi Personalizate

1. Ce model alegeți?

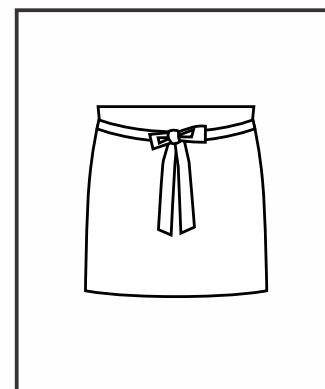

Scurt

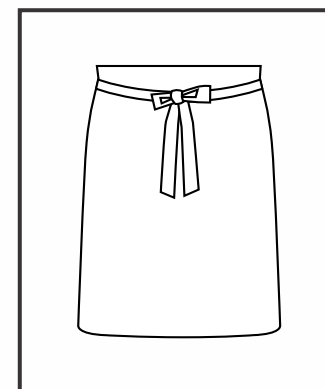

Mediu



Lung

2. Ce detalii alegeți?

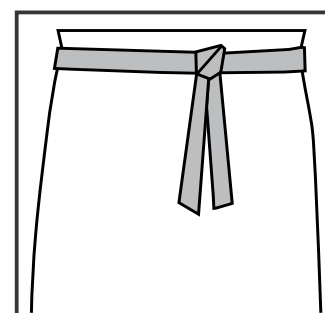

Legături contrast

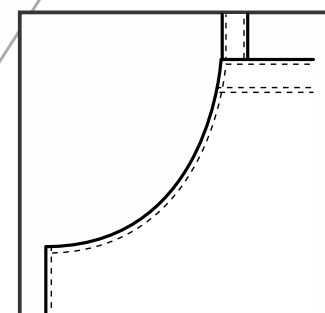

Legături aceeași culoare

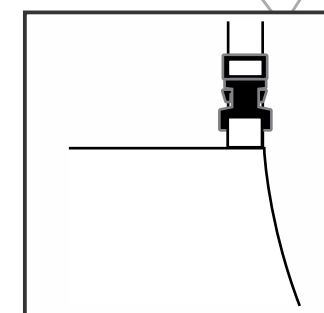

Clips ajustabil

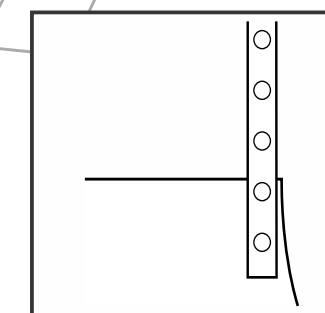

Bretea cu capse

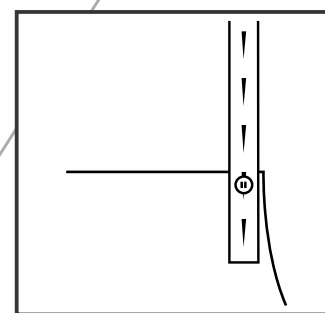

Bretea cu nasturi

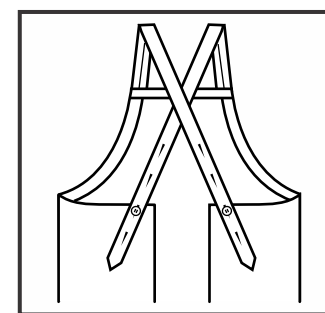

Bretele in cruce

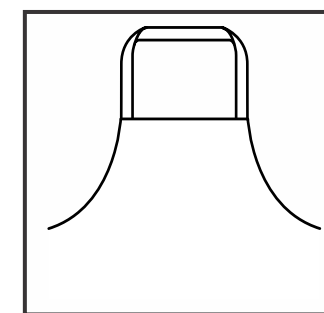

Bretele drepte

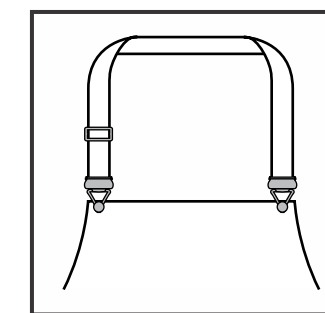

Bretele tip salopetă

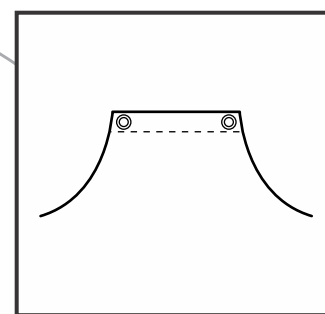

Ocheți

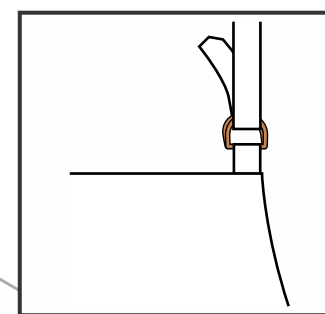

Închidere inele metal

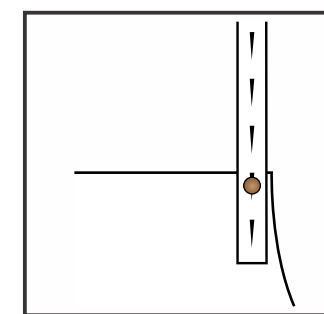

Bretea cu nasture de jeans

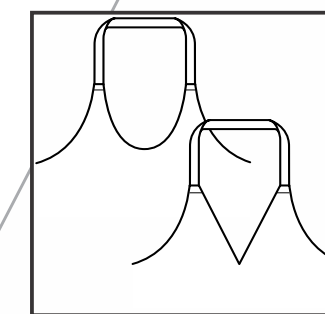

Guler rotunjit sau Guler in V



3. Ce tip de buzunare?

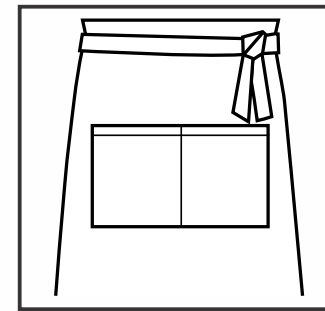

Buzunar lat
despărțit centru

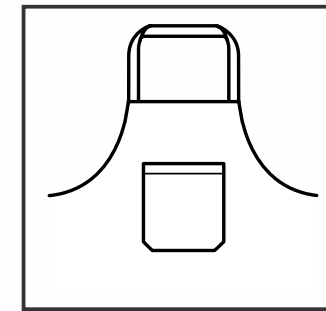

Buzunar piept

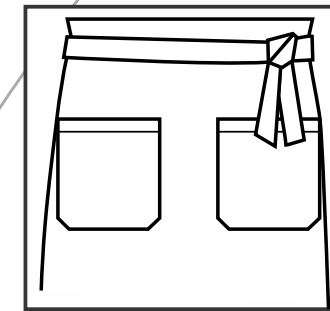

2 buzunare

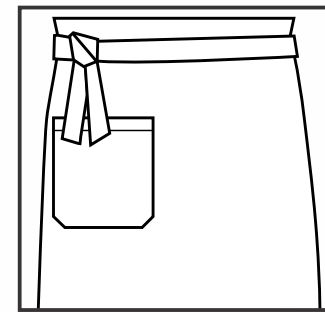

Buzunar dreapta

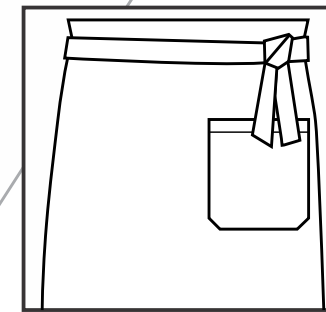

Buzunar stânga

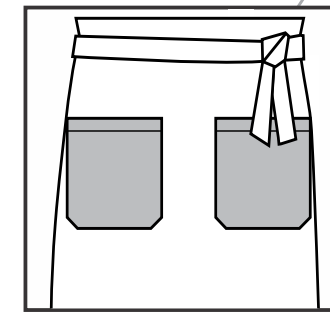

Buzunare contrast

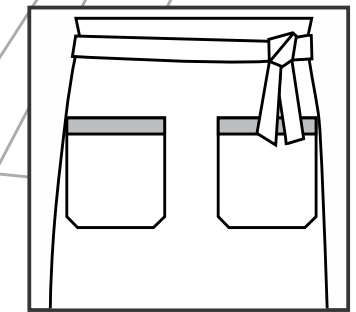

Buzunare contrast
tiv

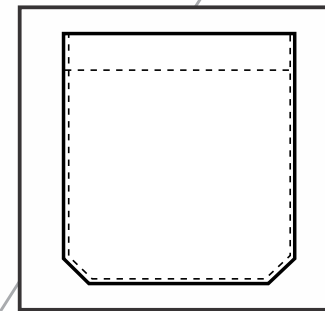

Buzunar rotunjit

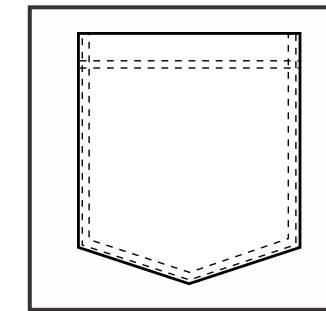

Buzunar ascuțit

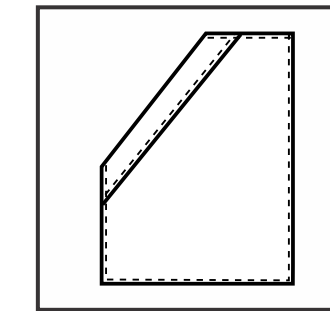

Buzunar anform

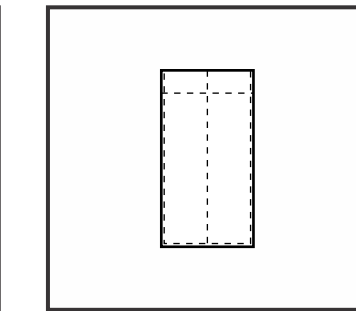

Buzunar pentru pix

4. Ce tip de talie?

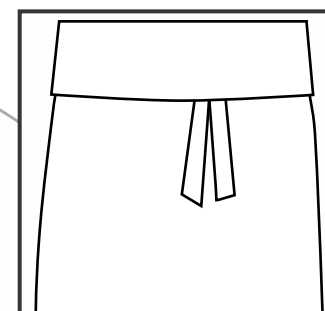

Pliat peste talie

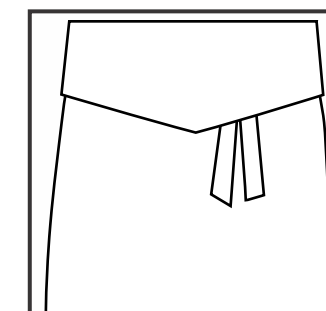

Pliat peste talie
anformat

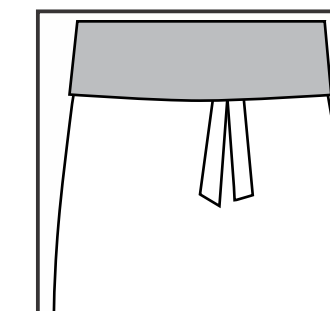

Pliat peste talie
cu contrast

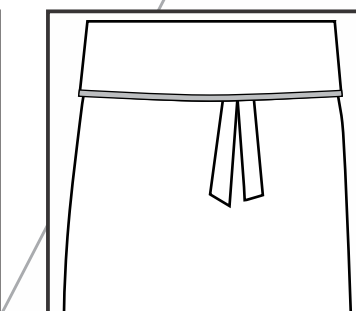

Pliat peste talie
cu vipușcă contrast



5. Ce fel de contrast?

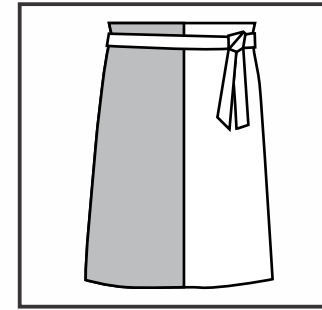

Contrast vertical

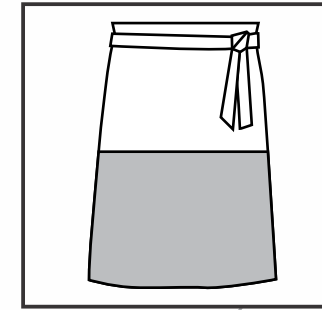

Contrast orizontal

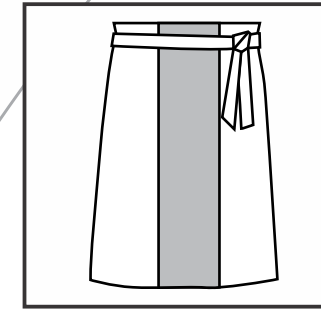

Contrast mijloc fața

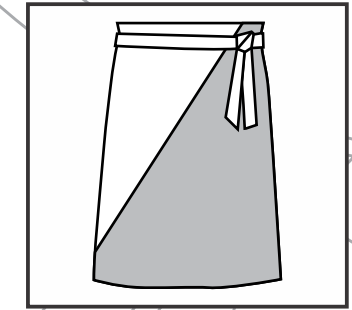

Contrast unghi

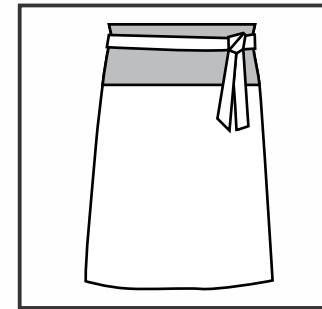

Contrast parte superioară

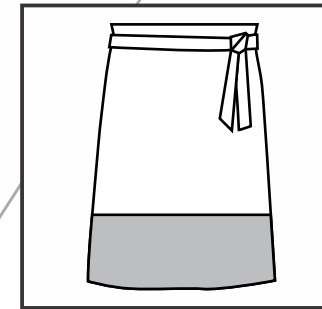

Contrast parte inferioară

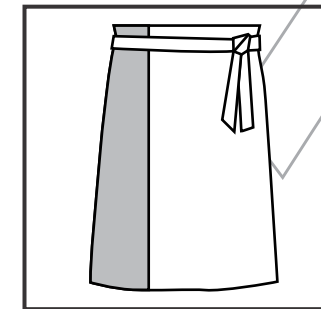

Contrast dreapta

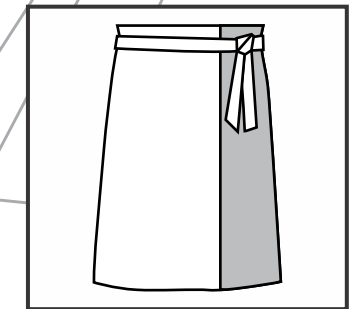

Contrast stânga

6. Ce culoare alegeți?

POLY/COTTON TWILL

black	bottle	brown	button blue	charcoal
coco beige	como blue	coraille	ecru	emerald
green tea	guess brown	hedgehog	hortensia	hospital blue
khaki	lilac	maize	aqua	magic azur
maroon	navy	new seville	nimbus	verbena
peacock	postman blue	piquant green	pretty pink	purple passion
royal	rusty red	scan red	sheer lilac	sherwood
shocking pink	sky	slate	cherry red	sulphur
teal	turquoise	vert	warm orange	white

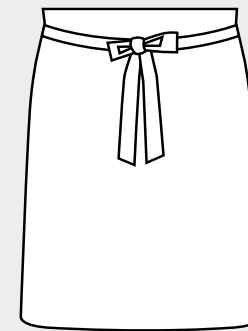

... o broderie cu
logo-ul tau

Poți adăuga.....

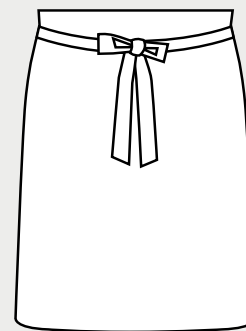

...sau o personalizare
prin transfer termic
sau serigrafie



Bonete





Bonete Personalizate

1. Ce model alegeți?

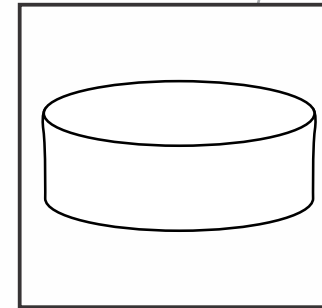

WILTON

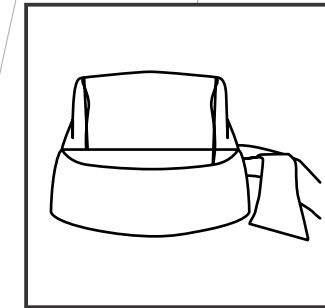

BRADFORD

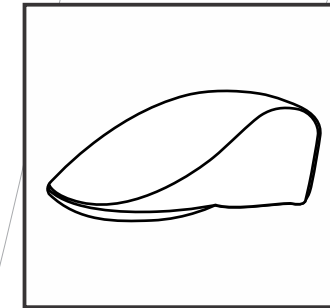

EPSOM

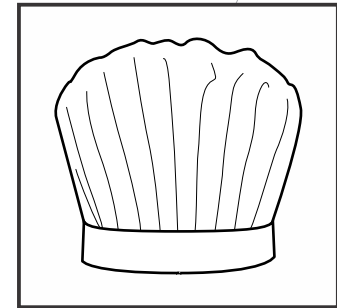

KENDAL

2. Ce culoare alegeți?

POLY/COTTON TWILL

black	bottle	brown	button blue	charcoal
coco beige	como blue	coraille	ecru	emerald
green tea	guess brown	hedgehog	hortensia	hospital blue
khaki	lilac	maize	aqua	magic azur
maroon	navy	new seville	nimbus	verbena
peacock	postman blue	piquant green	pretty pink	purple passion
royal	rusty red	scan red	sheer lilac	sherwood
shocking pink	sky	slate	cherry red	sulphur
teal	turquoise	vert	warm orange	white



Poți adăuga.....

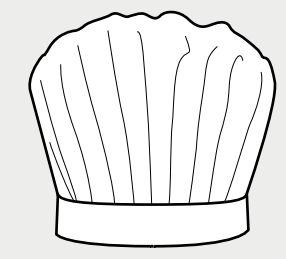
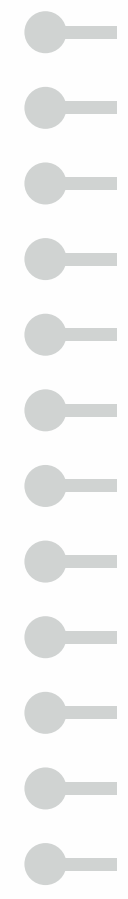

... o broderie cu
logo-ul tau

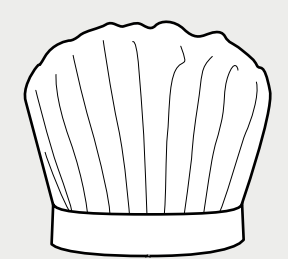

...sau o personalizare
prin transfer termic
sau serigrafie

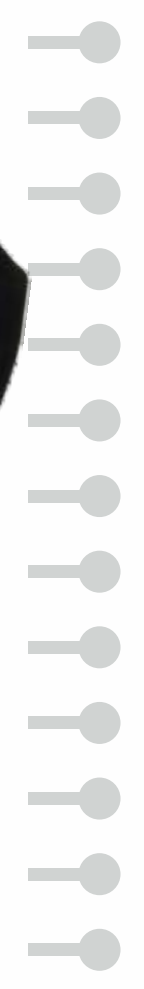

Pantaloni





Pantalon Personalizat

1. Ce model alegeți?

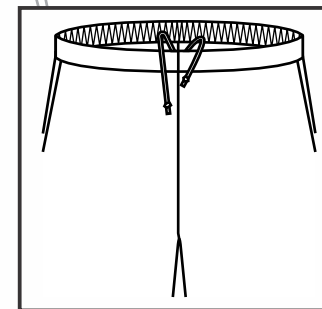
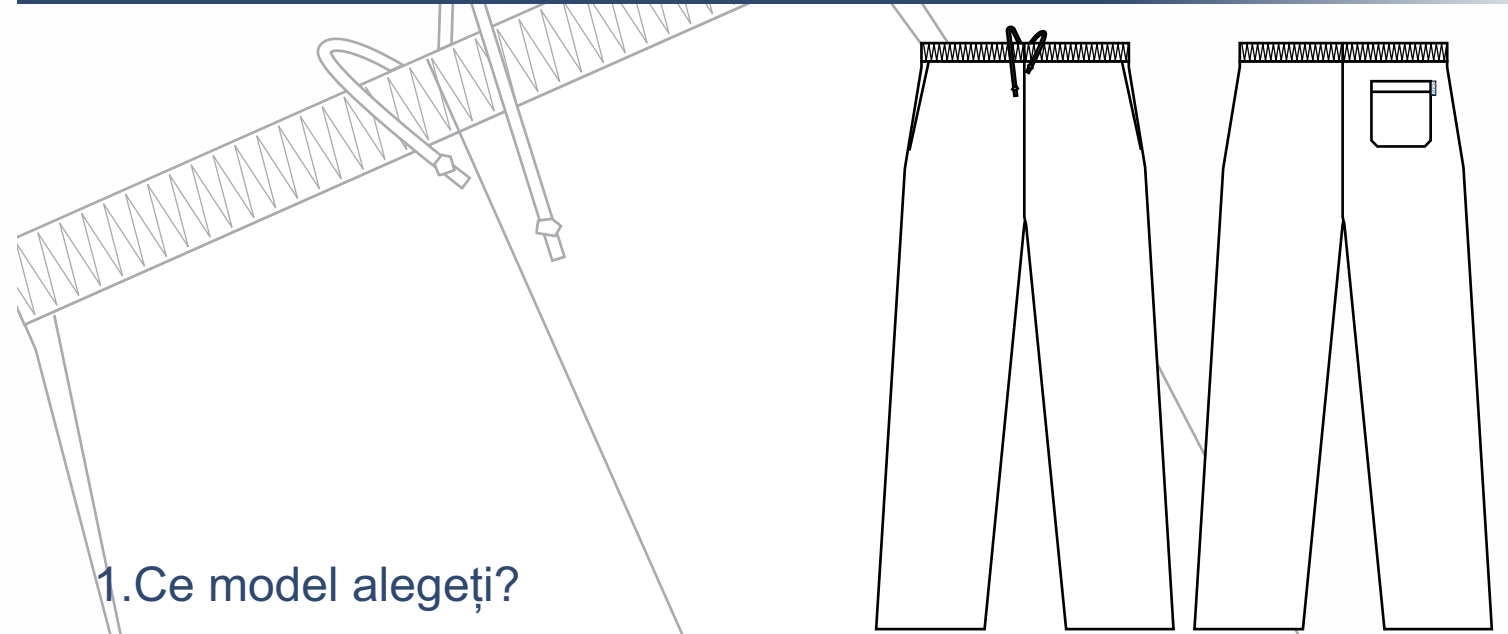

Elastic spate

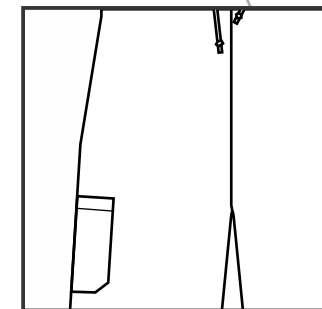

Buzunar lateral pentru lingura

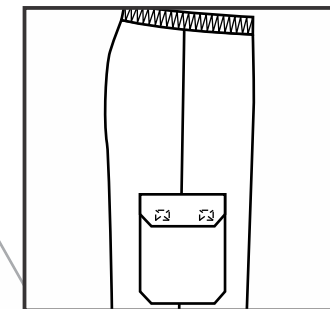

Buzunare laterale

2. Ce culoare alegeți?



POLY/COTTON TWILL

black	bottle	brown	button blue	charcoal
coco beige	como blue	coraille	ecru	emerald
green tea	guess brown	hedgehog	hortensia	hospital blue
khaki	lilac	maize	aqua	magic azur
maroon	navy	new seville	nimbus	verbena
peacock	postman blue	piquant green	pretty pink	purple passion
royal	rusty red	scan red	sheer lilac	sherwood
shocking pink	sky	slate	cherry red	sulphur
teal	turquoise	vert	warm orange	white

Pantaloni Unisex

MARIME	TALIE	SOLD	LUNGIME LATERALA
XS	75	100	101
S	79	104	102
M	83	108	103
L	87	114	104
XL	91	122	107
2XL	95	128	109
3XL	102	136	110

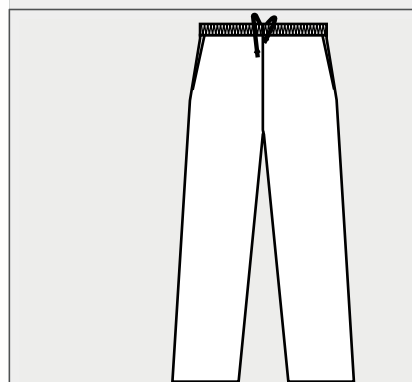

... o broderie cu logo-ul tau

Poți adăuga.....

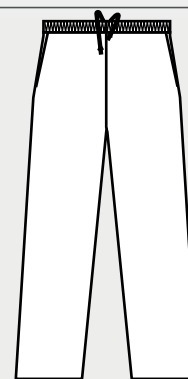

...sau o personalizare prin transfer termic sau serigrafie



Polar Fleece



Polar Fleece Personalizat



1. Ce model alegeți?

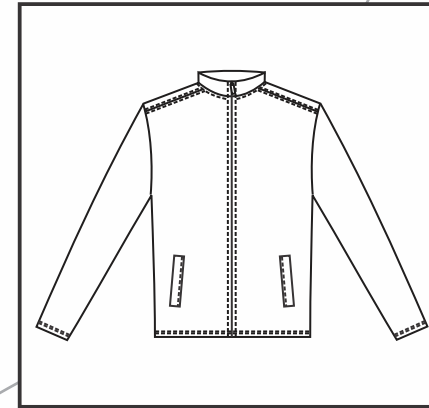

Polar fleece buzunare laterale

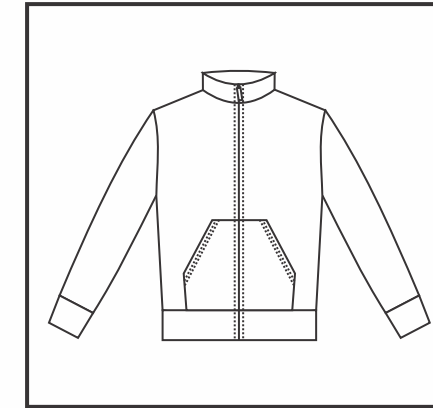

Polar fleece buzunar tip marsupiu

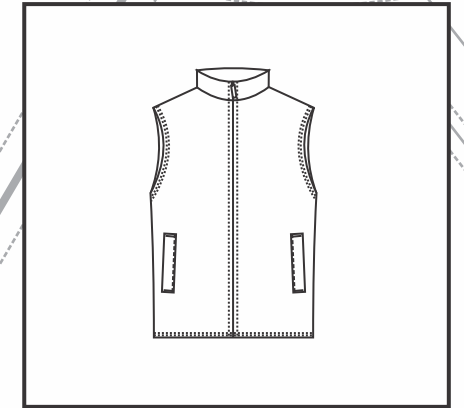

Polar fleece vestă

2. Ce culoare alegeți?



Polar Fleece Barbati

MARIME	BUST	SOLD	LUNGIME SPATE	LUNGIME MANECA
XS	102	102	68	63
S	110	110	71	64
M	118	118	74	65
L	126	126	75.5	66
XL	134	134	77	67
2XL	142	142	78.5	68
3XL	150	150	80	69
4XL	158	158	81.5	70

Polar Fleece Dama

MARIME	TALIE	SOLD	BUST	LUNGIME MANECA
XS	79	80	89	71
S	86	88	97	73
M	94	96	105	75
L	102	104	113	77
XL	110	112	121	79

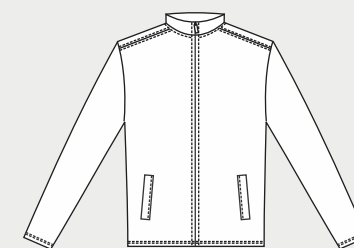

... o broderie cu logo-ul tau



Poți adăuga.....

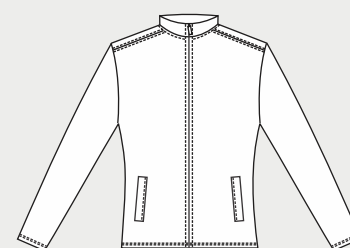

... o broderie cu logo-ul tau



Jachetă



Jachetă Personalizată

1. Ce model alegeți?

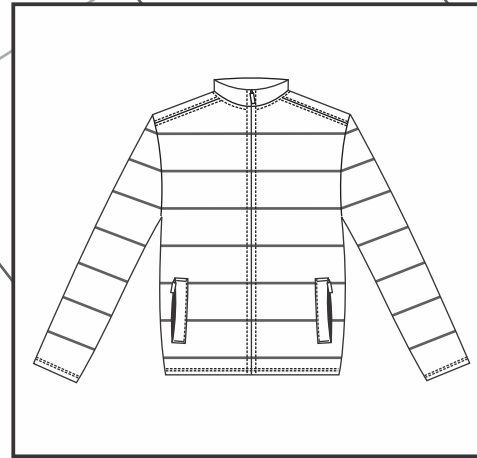

Model clasic

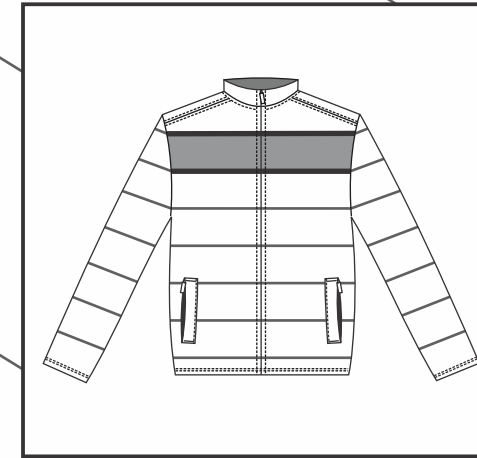

Model cu contrast piept

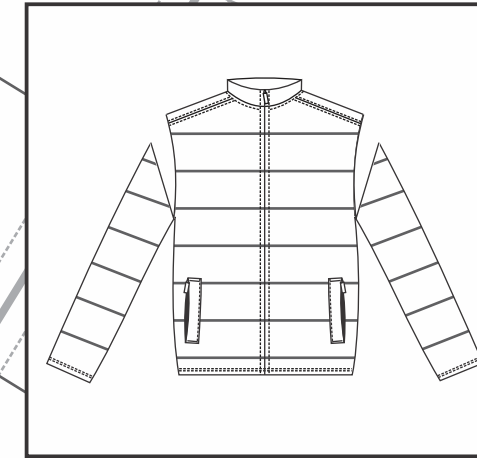

Model mâneci detașabile

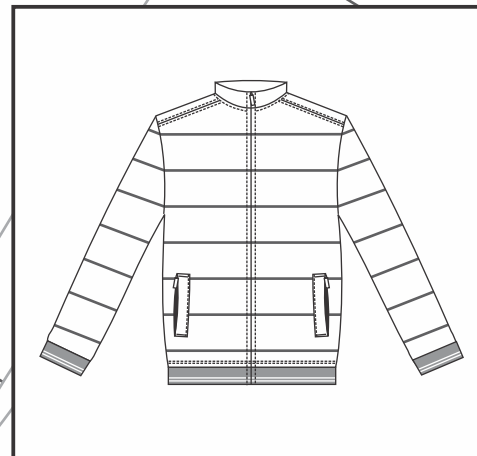

Model cu detalii patent

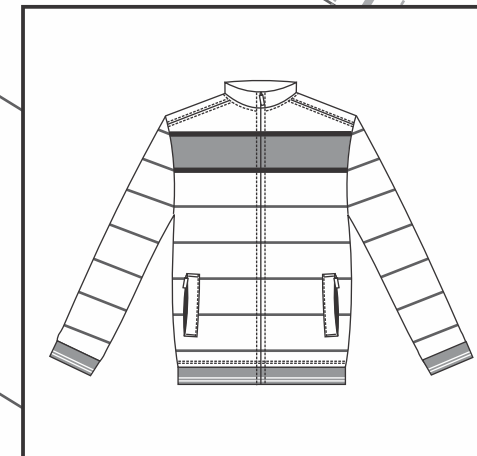

Model cu detalii patent și contrast piept

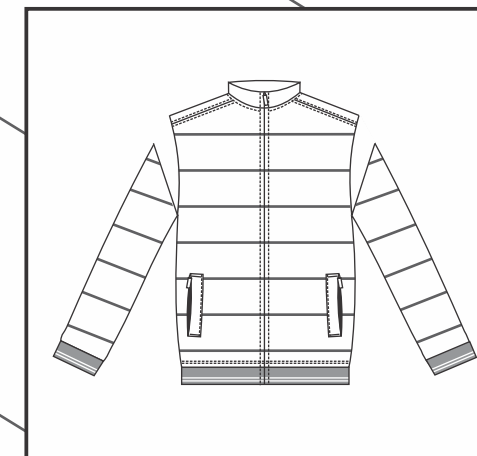

Model cu detalii patent și mâneci detașabile

2. Ce culoare alegeți?



Tricou Polo Dama
CLASIC FIT

MARIME	BUST	TALIE	LUNGIME SPATE	LUNGIME MANECA
XS	86	78	62	59
S	90	82	64	60
M	94	86	66	61
L	98	90	68	62
XL	102	94	70	63
2XL	110	102	74	65
3XL	118	110	78	67

MARIME	BUST	TALIE	LUNGIME SPATE	LUNGIME MANECA
XS	74 - 78	66 - 70	62	59
S	79 - 82	71 - 74	64	60
M	83 - 88	75 - 80	66	61
L	89 - 94	81 - 85	68	62
XL	90 - 95	86 - 90	70	63
2XL	100 - 105	92 - 97	74	65
3XL	108 - 113	100 - 105	78	67

Tricou Polo Dama
SLIM FIT

Tricou Polo Barbati
CLASIC FIT

MARIME	BUST	TALIE	LUNGIME SPATE	LUNGIME MANECA
XS	100	100	65	64
S	104	104	67	65
M	108	108	69	65
L	112	112	71	65
XL	116	116	73	66
2XL	120	120	75	66
3XL	124	124	77	66

MARIME	BUST	TALIE	LUNGIME SPATE	LUNGIME MANECA
XS	90 - 93	90 - 93	65	64
S	94 - 97	94 - 97	67	65
M	98 - 101	98 - 101	69	65
L	102 - 105	102 - 105	71	65
XL	106 - 109	106 - 109	73	66
2XL	110 - 113	110 - 113	75	66
3XL	114 - 117	114 - 117	77	66

Tricou Polo Barbati
SLIM FIT

Poți adăuga.....

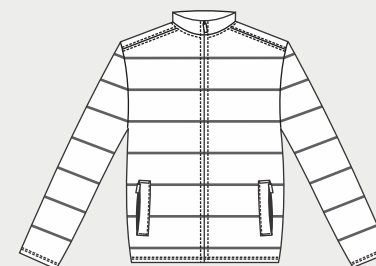

... o broderie cu
logo-ul tau

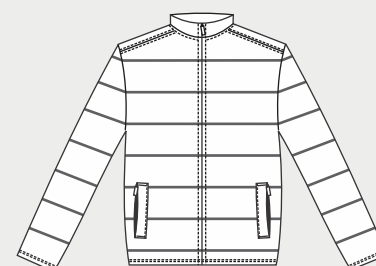

...sau o personalizare
prin transfer termic
sau serigrafie





Jachetă Personalizată

1. Ce model alegeți?

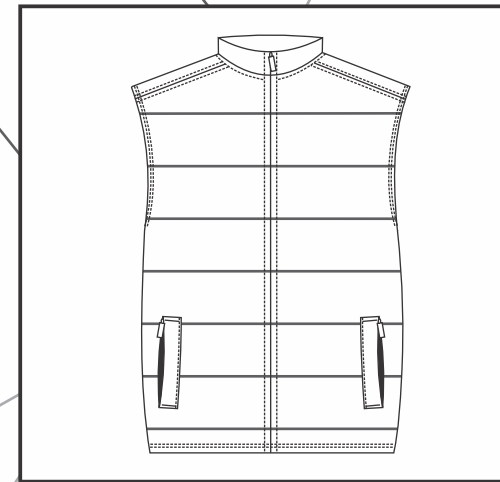

Model clasic

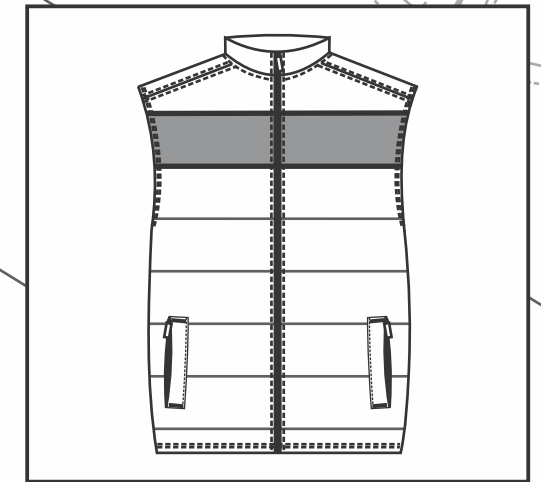

Model cu contrast piept

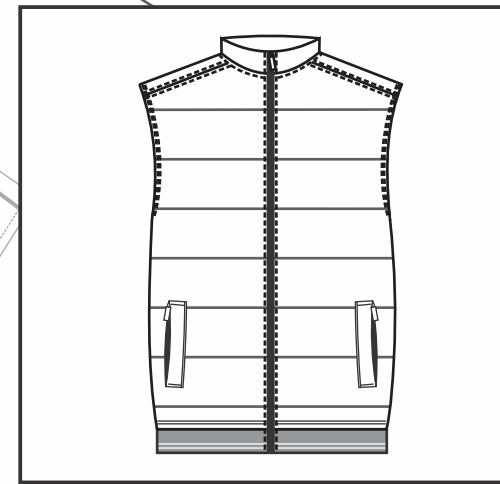

Model cu detalii patent

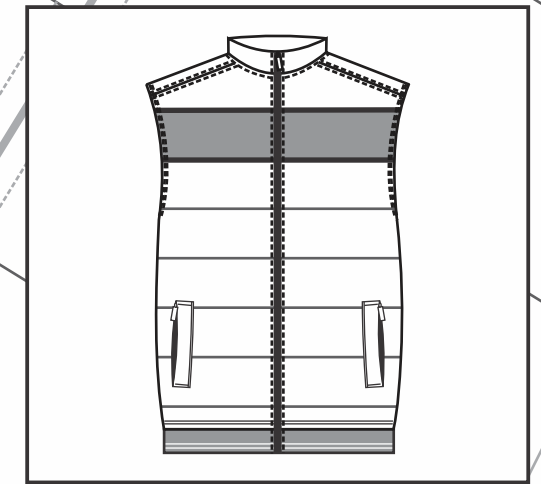

Model cu detalii patent și contrast piept

2. Ce culoare alegeți?

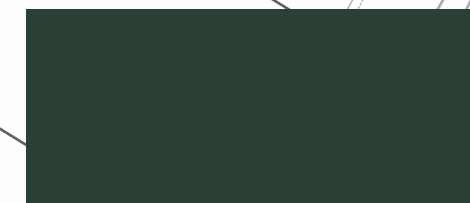

Poți adăuga.....

Vesta Barbati

MARIME	BUST	TALIE	LUNGIME SPATE
XS	102	110	71
S	110	116	72
M	118	122	73
L	126	128	74
XL	134	134	75
2XL	142	140	76
3XL	150	146	77

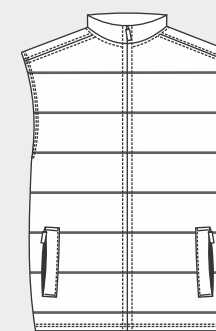

... o broderie cu logo-ul tau



Vesta Dama

MARIME	TALIE	SOLD	BUST	LUNGIME SPATE
XS	87	98	96	71
S	91	102	100	73
M	95	106	104	75
L	99	110	108	76.5
XL	103	114	112	78
2XL	107	118	116	80

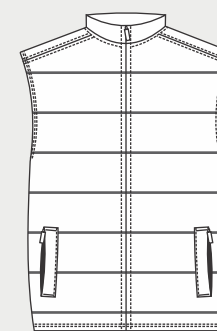

...sau o personalizare prin transfer termic sau serigrafie



Uniforme Agenți Pază

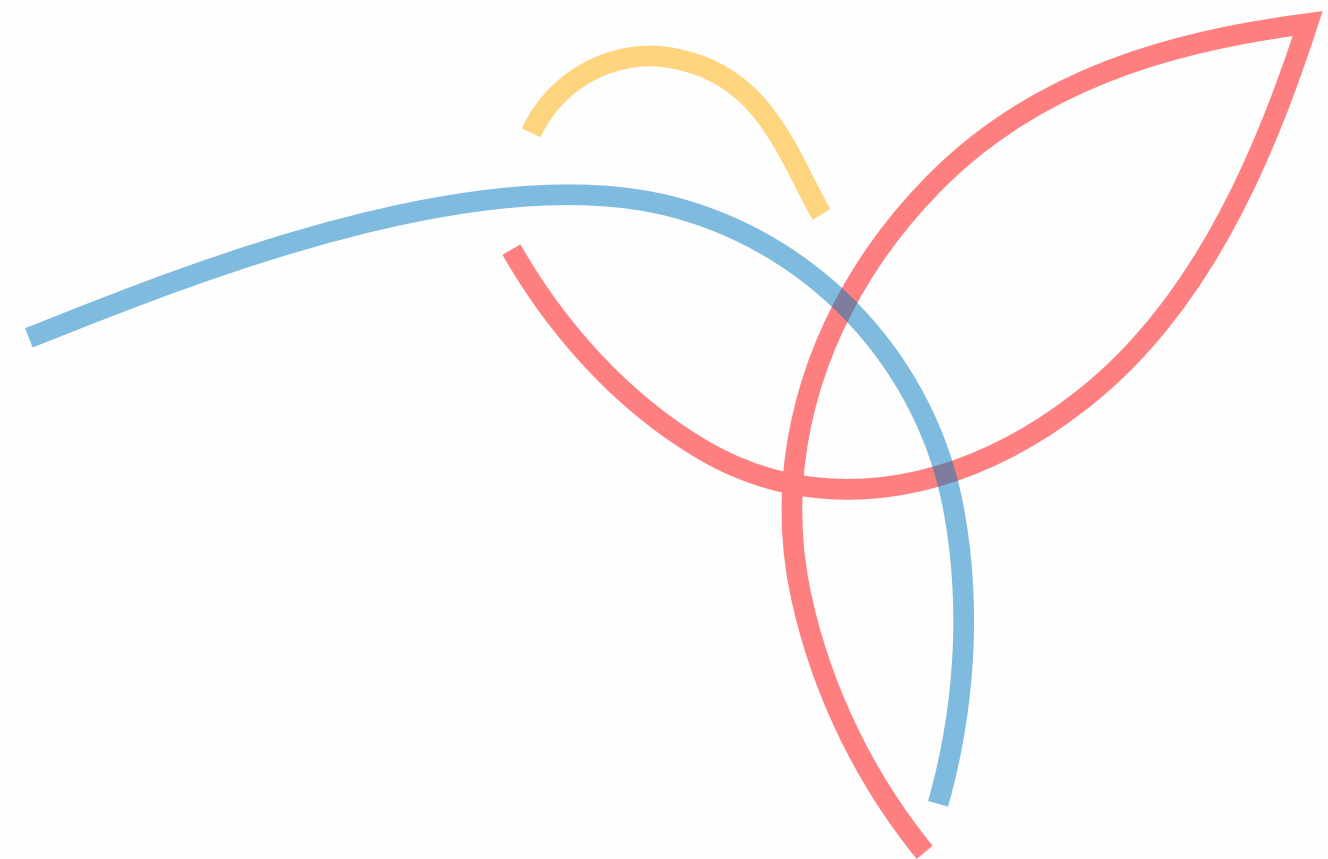

Uniforme Personalizate pentru Agenți de Pază

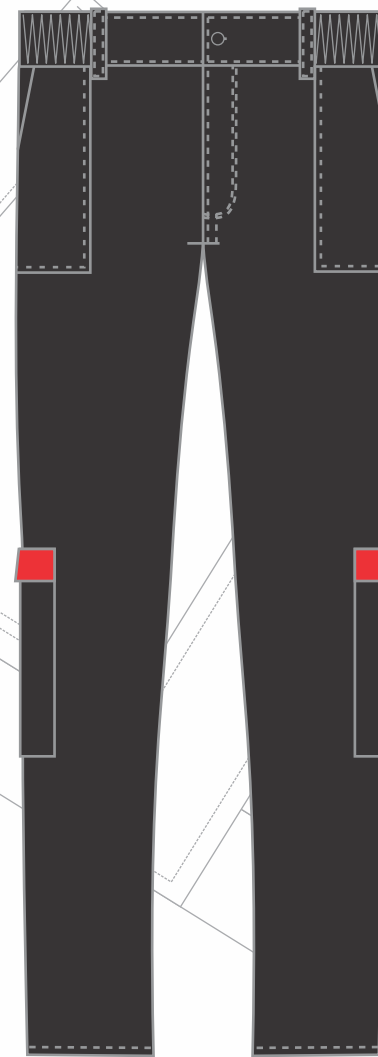

Tricou Polo Barbati
CLASIC FIT

MARIME	BUST	TALIE	LUNGIME SPATE	LUNGIME MANECA
XS	100	100	65	64
S	104	104	67	65
M	108	108	69	65
L	112	112	71	65
XL	116	116	73	66
2XL	120	120	75	66
3XL	124	124	77	66

Tricou Polo Barbati
SLIM FIT

MARIME	BUST	TALIE	LUNGIME SPATE	LUNGIME MANECA
XS	90 - 93	90 - 93	65	64
S	94 - 97	94 - 97	67	65
M	98 - 101	98 - 101	69	65
L	102 - 105	102 - 105	71	65
XL	106 - 109	106 - 109	73	66
2XL	110 - 113	110 - 113	75	66
3XL	114 - 117	114 - 117	77	66



... o broderie cu
logo-ul tau

Poți adăuga.....



...sau o personalizare
prin transfer termic
sau serigrafie



Tricou Polo Barbati
CLASIC FIT

MARIME	BUST	TALIE	LUNGIME SPATE	LUNGIME MANECA
XS	100	100	65	64
S	104	104	67	65
M	108	108	69	65
L	112	112	71	65
XL	116	116	73	66
2XL	120	120	75	66
3XL	124	124	77	66



Poți adăuga.....

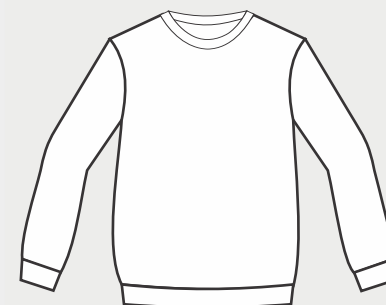

... o broderie cu
logo-ul tau

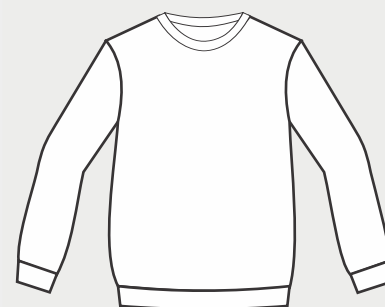

...sau o personalizare
prin trasnfer termic
sau serigrafie



Tricou Polo Barbati
CLASIC FIT

MARIME	BUST	TALIE	LUNGIME SPATE	LUNGIME MANECA
XS	100	100	65	64
S	104	104	67	65
M	108	108	69	65
L	112	112	71	65
XL	116	116	73	66
2XL	120	120	75	66
3XL	124	124	77	66



... o broderie cu
logo-ul tau



Poți adăuga.....



...sau o personalizare
prin transfer termic
sau serigrafie



Tricou Polo Barbati
CLASIC FIT

MARIME	BUST	TALIE	LUNGIME SPATE	LUNGIME MANECA
XS	100	100	65	64
S	104	104	67	65
M	108	108	69	65
L	112	112	71	65
XL	116	116	73	66
2XL	120	120	75	66
3XL	124	124	77	66

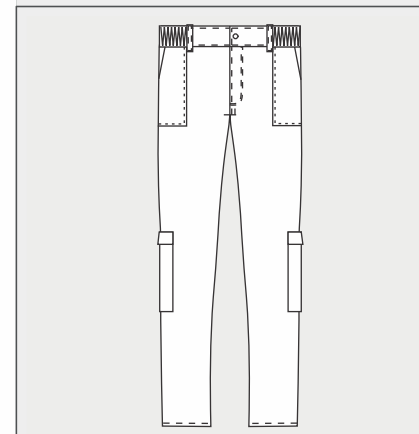

... o broderie cu
logo-ul tau

Poți adăuga.....

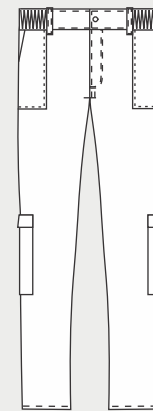
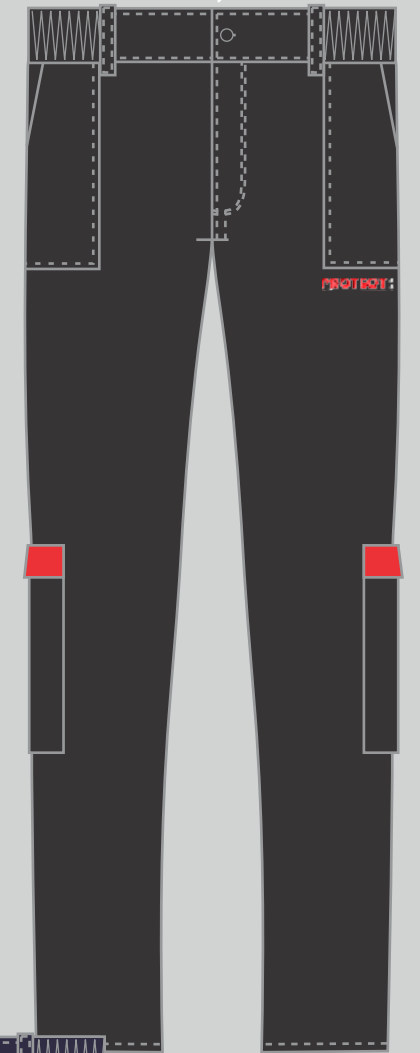

...sau o personalizare
prin transfer termic
sau serigrafie

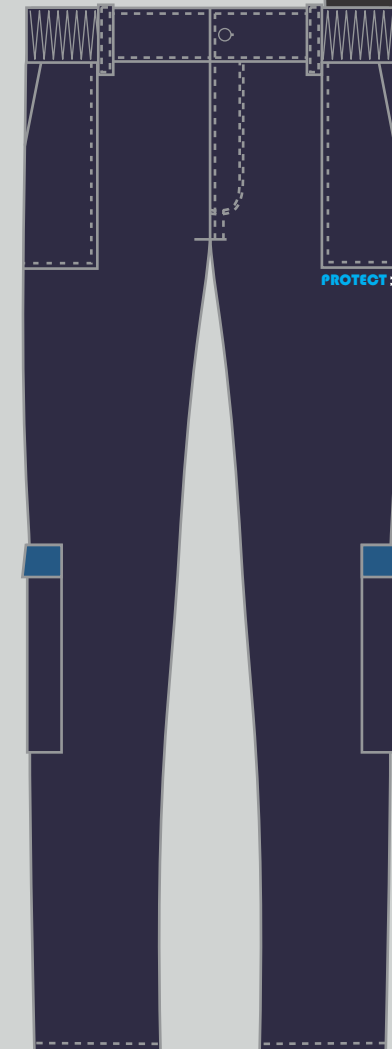

Uniforme Medici

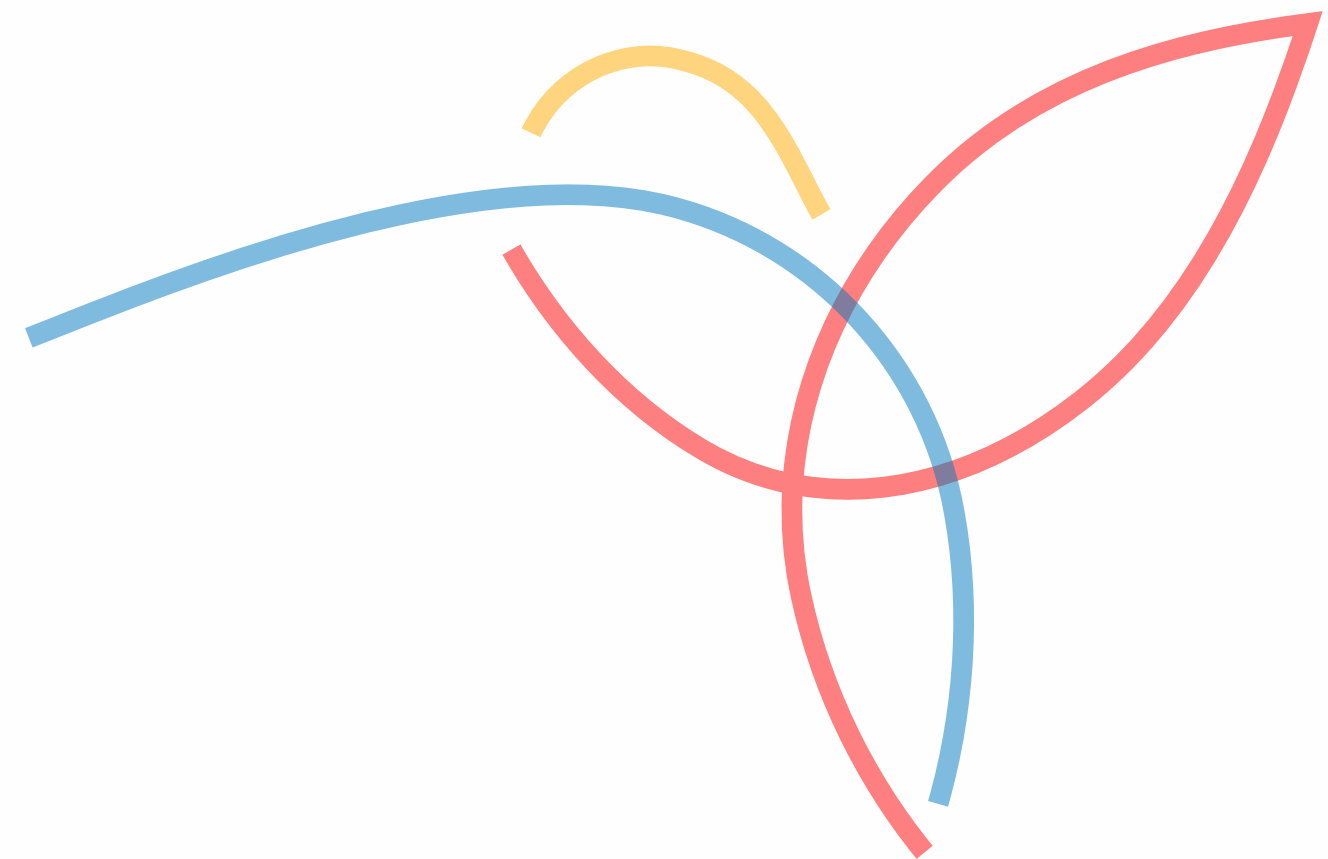

Uniforme Personalizate pentru Medici



Poți adăuga.....

Tricou Polo Dama
CLASIC FIT

MARIME	BUST	TALIE	LUNGIME SPATE	LUNGIME MANECA
XS	86	78	62	59
S	90	82	64	60
M	94	86	66	61
L	98	90	68	62
XL	102	94	70	63
2XL	110	102	74	65
3XL	118	110	78	67

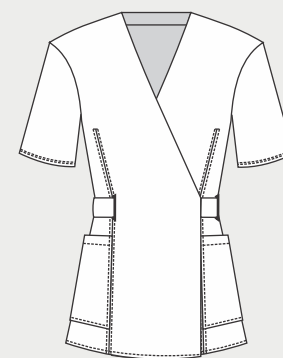

... o broderie cu
logo-ul tau

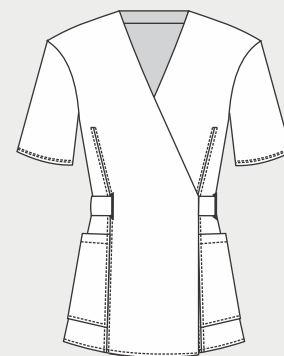
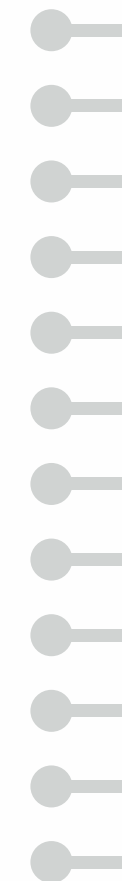

...sau o personalizare
prin trasnfer termic
sau serigrafie

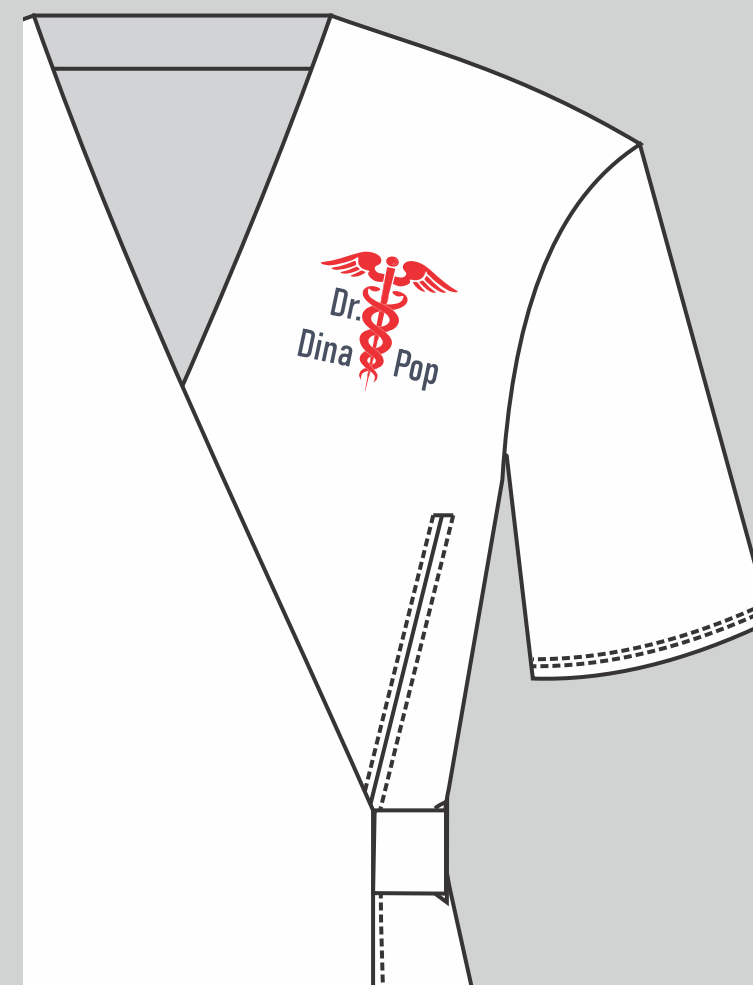

Tricou Polo Dama
CLASIC FIT

MARIME	BUST	TALIE	LUNGIME SPATE	LUNGIME MANECA
XS	86	78	62	59
S	90	82	64	60
M	94	86	66	61
L	98	90	68	62
XL	102	94	70	63
2XL	110	102	74	65
3XL	118	110	78	67

Tricou Polo Barbati
CLASIC FIT

MARIME	BUST	TALIE	LUNGIME SPATE	LUNGIME MANECA
XS	100	100	65	64
S	104	104	67	65
M	108	108	69	65
L	112	112	71	65
XL	116	116	73	66
2XL	120	120	75	66
3XL	124	124	77	66



Poți adăuga.....

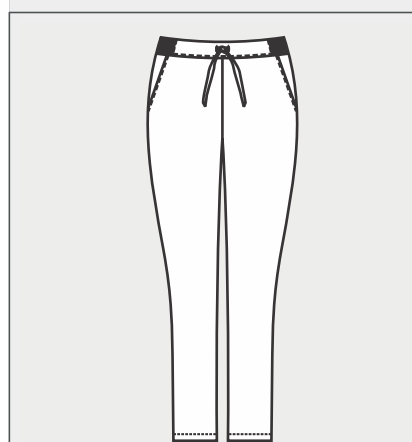

... o broderie cu
logo-ul tau

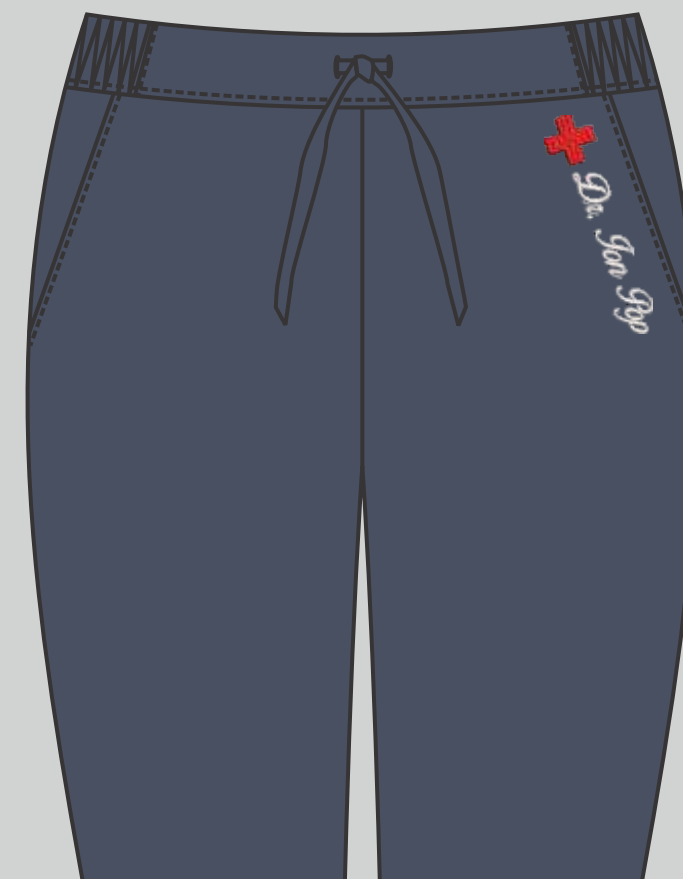

...sau o personalizare
prin transfer termic
sau serigrafie

